

Mullion Doors Ordering Procedures

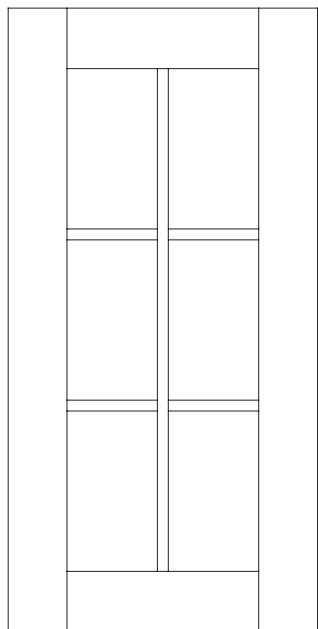

Muntin Profiles



Artisan
Harmony
Marquis
Prescott
Rivington
Simsbury
Toulan

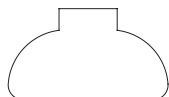

Galleria
Girard
Kingston
Madison
Plaza
Verona

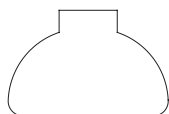

Avignon
Lexington

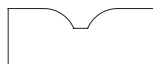

Cambridge

When ordering glass mullion doors, use Decorá's standard cabinet item number (W3030, W2430, DW2430, etc.) and then designate the corresponding option name (see below) in the description portion of the purchase order.

All glass mullion doors ordered will be of the same wood specie, finish, door style, hinge selection, and profile as the other cabinets specified on the original kitchen order unless instructed otherwise.

DMR standard interior—unless requested otherwise. Finished interior is an option.

Door is prepared for glass insert; dealer must supply glass. Designed to utilize one piece of glass per door—not separate panes. Clips for inserting glass included in installation package. Doors are pre-drilled for clips.

Not available on cabinets with bi-fold doors.

Finished Interior must be specified if desired.

Option Name	Cabinet Height	Number of Lites per Door
MD15	15"	4
MD18	18"	4
MD21	21"	4
MD24	24"	4
MD27	27"	4
MD30	30"	6
MD33	33"	6
MD36	36"	6
MD39	39"	8
MD42	42"	8
MD45	45"	8
MD48	48"	8

NOTE: Mullion doors are NOT available in cabinets less than 15" or more than 48" high or in cabinets less than 12" wide. Not available in Braydon Manor, Daladier, Davenport, Hawthorne, Huchenson, Leyden, Modesto, Savannah, Treyburn, Willshire, and Yardley door styles.

Prairie Mullion Doors Ordering Procedures

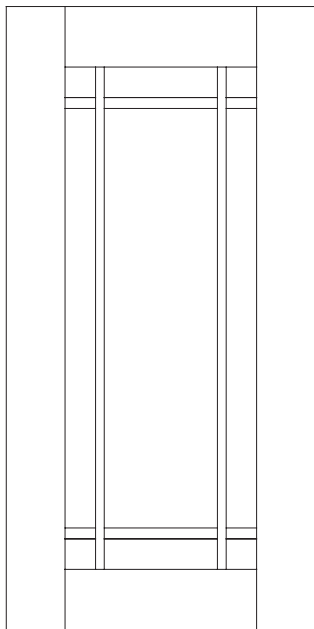

When ordering Prairie glass mullion doors, use Decorá's standard cabinet item number (W3030, W2430, DW2430, etc.) and then designate the corresponding option name (see below) in the description portion of the purchase order.

All glass mullion doors ordered will be of the same wood specie, finish, door style, hinge selection, and profile as the other cabinets specified on the original kitchen order unless instructed otherwise.

Door is prepared for glass insert; dealer must supply glass. Designed to utilize one piece of glass per door—not separate panes. Clips for inserting glass included in installation package. Doors are pre-drilled for clips.

Not available on cabinets with bi-fold doors.

Prairie mullion doors are NOT available in Roman arch door styles.

Not available in Braydon Manor, Daladier, Davenport, Hawthorne, Huchenson, Leyden, Modesto, Savannah, Treyburn, Willshire, and Yardley door styles.

Finished Interior must be specified if desired.

DMR standard interior—unless requested otherwise. Finished interior is an option.

Option Name	Cabinet Height
PRMD18	18"
PRMD21	21"
PRMD24	24"
PRMD27	27"
PRMD30	30"
PRMD33	33"
PRMD36	36"
PRMD39	39"
PRMD42	42"
PRMD45	45"
PRMD48	48"

Prairie mullion doors are NOT available in cabinets less than 18" or more than 48" high or in cabinets 9" and 12" wide.

Aluminum Frame Doors (ALF) with Frost Glass

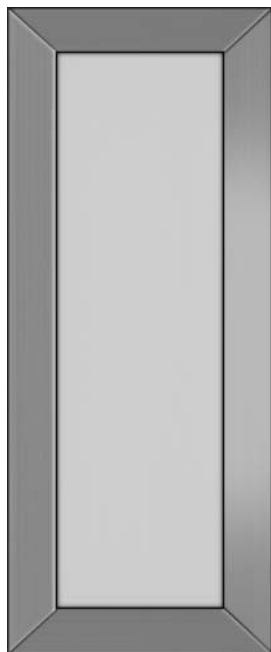

All aluminum doors will be full overlay with mitre construction.

Cabinet face frame will be matched to the finish specified.

Cabinet will have standard interior unless otherwise specified.

Frost glass is installed in door. Removal of glass will void warranty.

Available only on full overlay door styles.

Not available with Modified Full Overlay.

Cabinet Availability	Modification	Door Only*
W1230	ALF30	ALF1230
W1236	ALF36	ALF1236
W1530 PW1530 WTH3015	ALF30	ALF1530
W1536 PW1536 WTH3615	ALF36	ALF1536
W1830 PW1830 WTH3018	ALF30	ALF1830
W1836 PW1836 WTH3618	ALF36	ALF1836
W2130 PW2130	ALF30	ALF2130
W2136 PW2136	ALF36	ALF2136

*Hinges are not included.

Decorative Glass Insert

Art Glass Inserts

Style	Panel Thickness	Caming Material	Modification Code
Aston Hall	1/4"	Zinc	ASTO__
Belfast	1/4"	Zinc Black Patina	BELF__
Bungalow	1/4"	Zinc	BUNG__
Chelsea	1/4"	Brass	CHEL__
Edinburgh Brass	1/4"	Brass	EDBR__
Edinburgh Patina	1/4"	Zinc Black Patina	EDPA__
Hannover	1/4"	Brass	HANN__
Kensington	1/4"	Zinc Black Patina	KENS__
Luxembourg	1/4"	Zinc	LUXE__
Nottingham	1/4"	Zinc	NOTT__
Pasadena	1/4"	Zinc Black Patina	PASA__
Prairie*	1/4"	Copper	PRAI__
Tewkesbury	1/4"	Zinc	TEWK__
Windermere	1/4"	Zinc Black Patina	WIND__
Winslow	1/4"	Zinc	WINS__

*Prairie Art Glass not available in 9", 12", 27", or 2W24" wide cabinets.

Art Glass not available on Transom Door Cabinets or Wall Top Hinge with Stay Lift Cabinets.

Art and Textured Decorative Glass Inserts not available on LSB33, LSB36, CWs, SBCs, SSSs, SLSBs, DSSS33s, and 9" wide cabinets.

ID door must be ordered separately.

Height availability: 15" - 48" in 3" increments. Some sizes not available.

Textured Glass Inserts

Style	Panel Thickness	Modification Code
Antique [†]	1/8"	ANTQ__
Beveled [†]	1/4"	BEVE__
Clear [†]	1/4"	CLEA__
Diamond Lattice [†]	1/4"	DIAL__
Frost [†]	5/32"	FROS__
Kaleidoscope Aluminum	1/4"	KAAL__
Metallic Bronze Fabric	3/16"	MBRF__
Morisco [†]	1/4"	MORS__
Reeded [†]	5/32"	RDED__
River Reed [†]	1/4"	RIRD__
Seeded	9/32"	SEED__
Smoked Bevel [†]	1/4"	SMBV__
Thin Reeded [†]	1/8"	TRDE__

[†]Antique, Beveled, Clear, Diamond Lattice, Frost, Morisco, River Reed, Reeded, Smoked Bevel, and Thin Reeded not available in W0912, W1212, 2W2412 and W2712.

Seeded, Metallic Bronze Fabric, and Kaleidoscope available on 12" wide Transom Door Cabinets. All textured glass available on Transom cabinets greater than 12" wide.

Art and Textured Decorative Glass Inserts not available on LSB33, LSB36, CWs, SBCs, SSSs, SLSBs, DSSS33s, and 9" wide cabinets.

ID door must be ordered separately.

Height availability: 12" - 48" in 3" increments.

Decorative Art Glass Doors*



Aston Hall

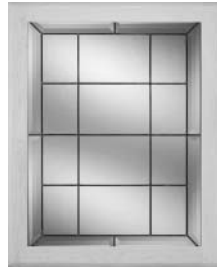

Edinburgh Patina



Pasadena



Belfast



Hannover



Prairie



Bungalow



Kensington



Tewkesbury



Chelsea



Luxembourg



Windermere



Edinburgh Brass



Nottingham



Winslow

*Suggested for use with Square door styles

Decorative Textured Glass Doors



Antique

Clear glass with surface striations simulating the texture and appearance of popular mouthblown antique glass. Uniform thickness, color, texture, highly transparent.

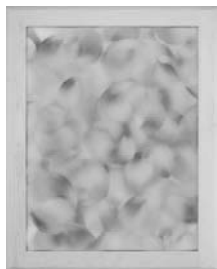

Kaleidoscope Aluminum

Laminated clear glass with a decorative brushed aluminum interlayer.



Seeded

Clear textured 9/32" glass with "seeds," small air bubbles trapped in the glass at random. Transparent in appearance.



Beveled*

1/4" clear glass with a 1 1/4" bevel. Transparent in appearance.



Metallic Bronze Fabric

Laminated clear glass with a metallic bronze fabric interlayer. Translucent in appearance.

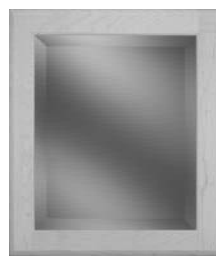

Smoked Bevel

1/4" grey tinted tempered glass with a 1" beveled edge.

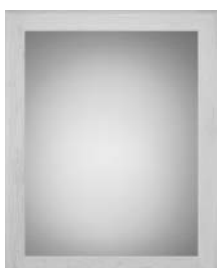

Clear

Clear glass.



Morisco

5/32" obscure tempered glass with a unique, raised, repetitive pattern.

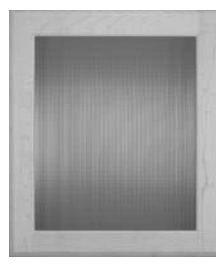

Thin Reeded

5/32" tempered glass with 1/8" vertical reeds—obscure in appearance.



Diamond Lattice

Laminated clear glass with a diamond wire pattern interlayer. Transparent in appearance.

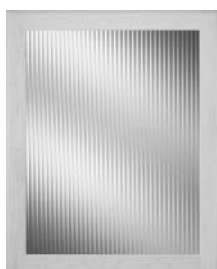

Reeded

Clear glass with 1/2" flutes or reeds. Transparent in appearance.

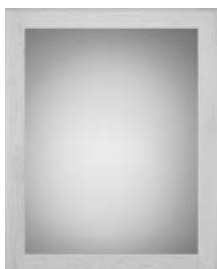

Frost

Clear glass with one surface "acid etched" to create a frosted appearance. Translucent in appearance.



River Reed

5/32" obscure tempered glass with a random, vertical pattern resembling small twigs.

*Suggested for use with Square door styles. Not suggested for use with Yardley.

Aston Hall

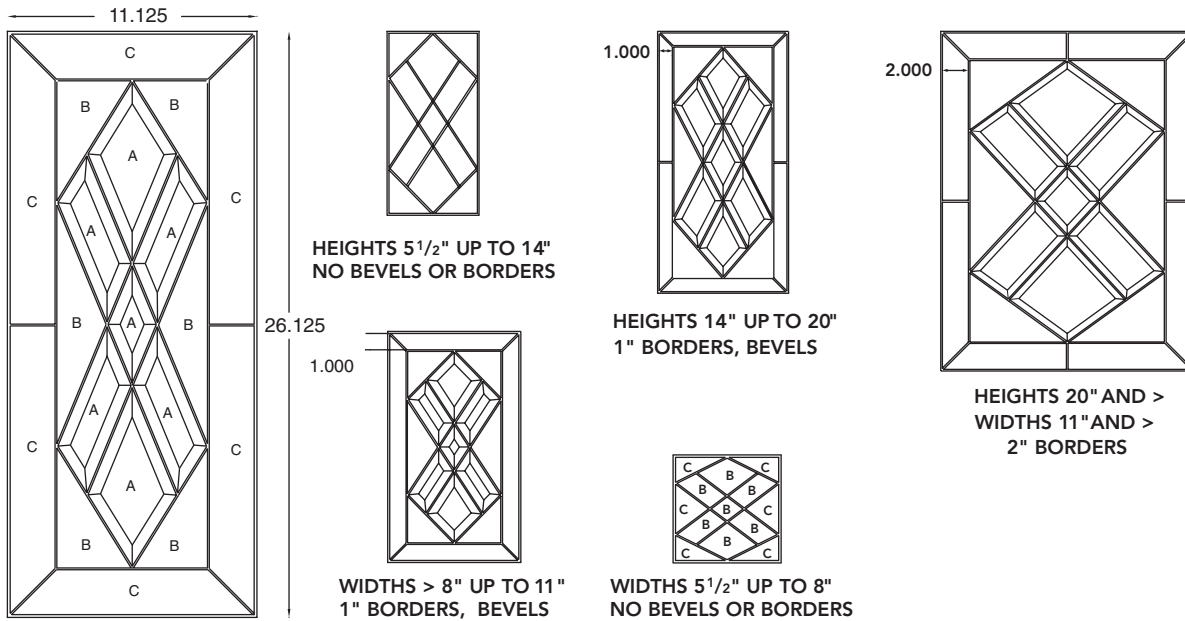

Glass Types:

- A) $\frac{3}{16}$ " Clear W $\frac{1}{2}$ " BEVEL
- B) $\frac{1}{8}$ " Clear
- C) Clear Waterglass 100W

Metal Types:

- $\frac{3}{16}$ " H-CH ZINC PROGLAZE2 (ALL)

Minimum Width $5\frac{1}{2}$ "
Minimum Height $5\frac{1}{2}$ "

Belfast

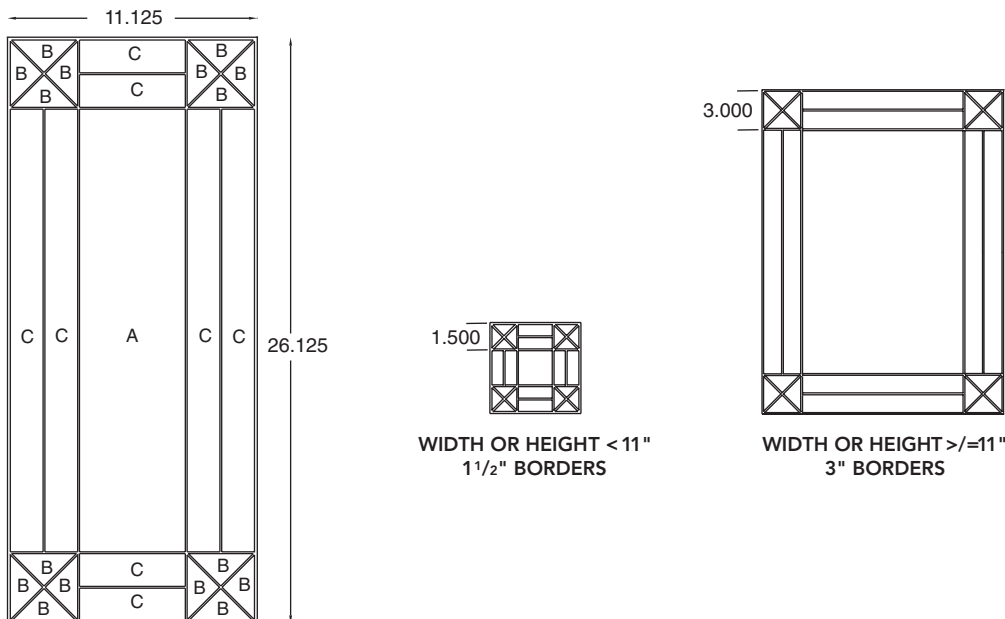

Glass Types:

- A) $\frac{3}{16}$ " Clear
- B) Frost ETCH 100
- C) Seedy Clear 100SDY

Metal Types:

- $\frac{3}{16}$ " H-CH ZINC PROGLAZE2 (All) Patina

Minimum Width $5\frac{1}{2}$ "
Minimum Height $5\frac{1}{2}$ "

Specialty Doors

Bungalow

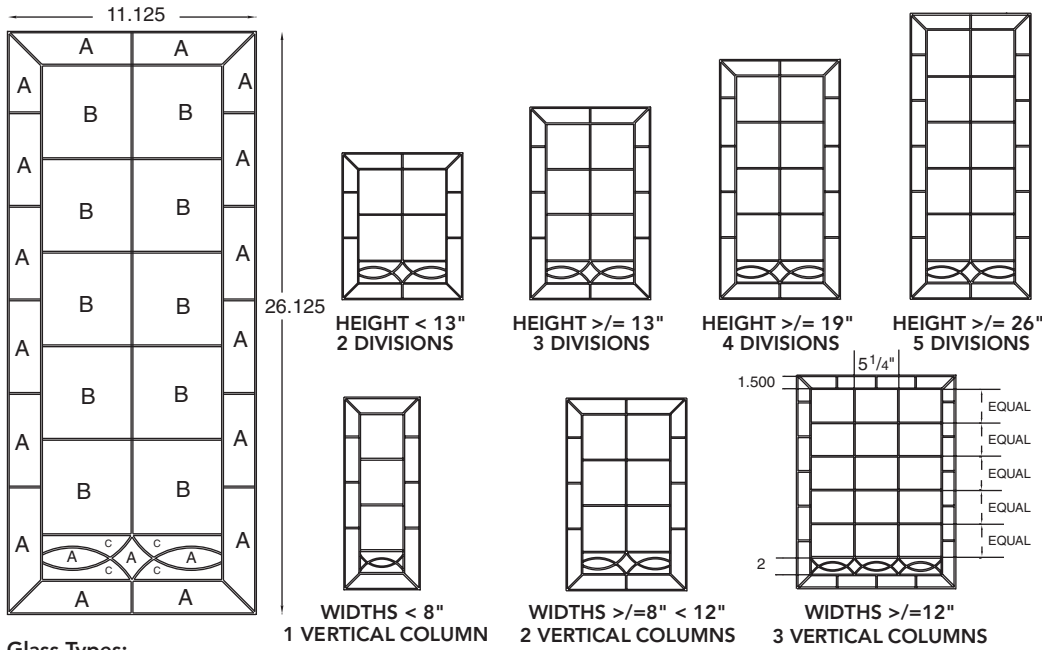

Glass Types:

- A) Clear & White, Translucent "Feather" 307S
- B) Clear Rough Rolled 100 RR
- C) Frost Etch 100W

Minimum Width 5 1/2"
 Minimum Height 9"
 (N/A In 12"-15" High)

Metal Types:

3/16" H-CH Zinc PROGLAZE2 (All)

Chelsea

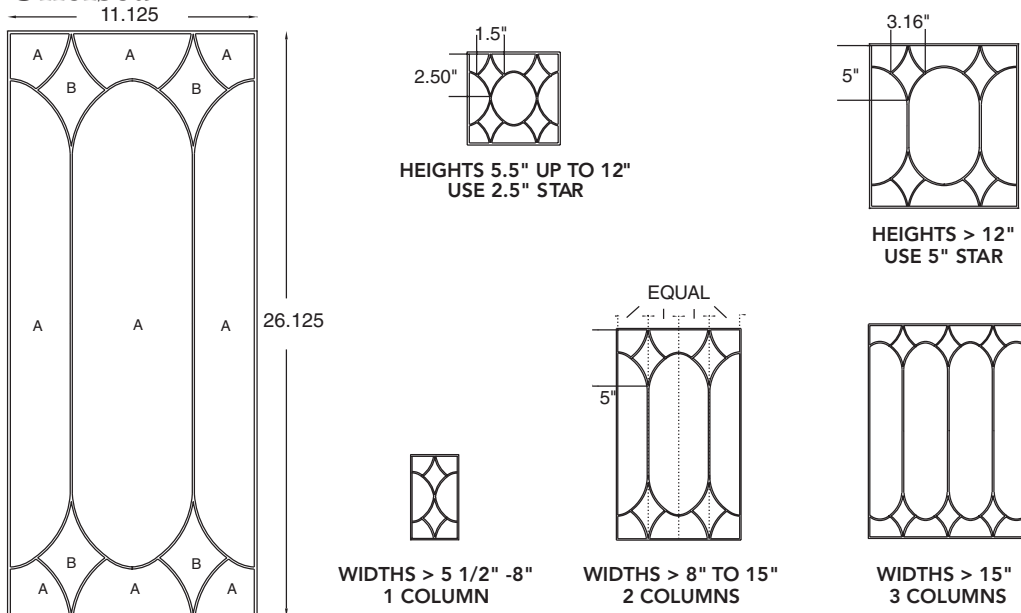

Glass Types:

- A) Clear Artique 100-A
- B) Clear Granite 100G

Minimum Width 5 1/2"
 Minimum Height 5 1/2"

Metal Types:

3/16" H-CH Brass PROGLAZE2 (All)

Edinburgh Brass

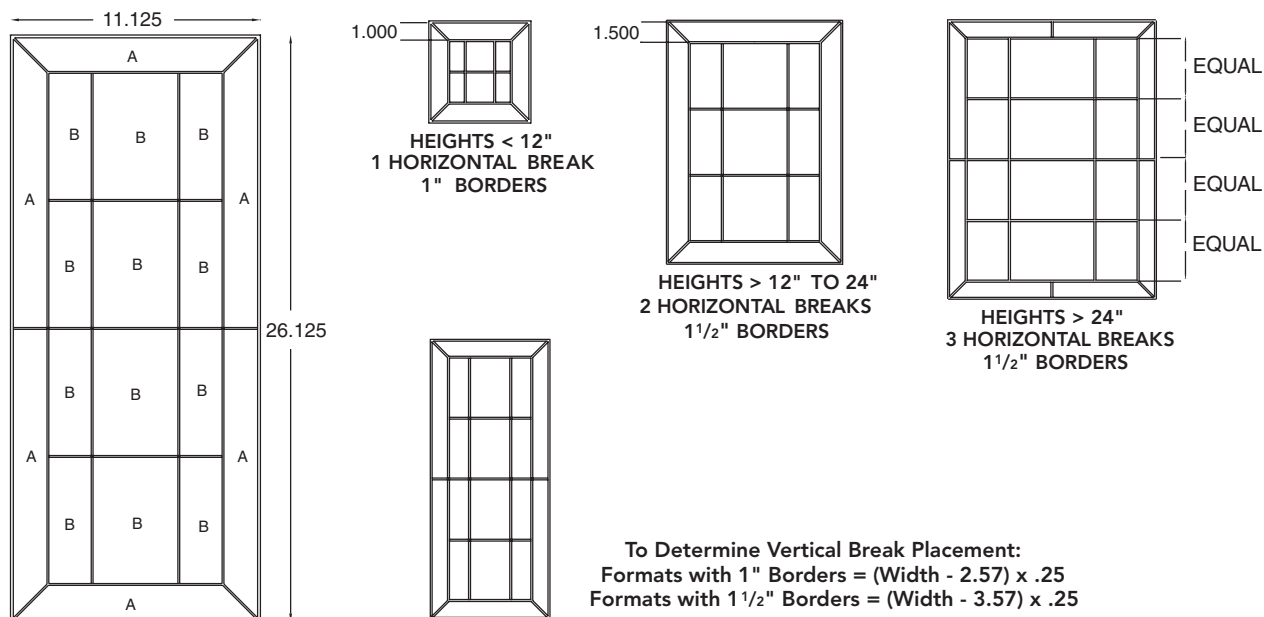

Glass Types:

- A) 1/8" Clear
- B) Clear Artique 100A

Metal Types:

3/16" H-CH Zinc PROGLAZE2 (All)

Minimum Width 5 1/2"
Minimum Height 5 1/2"
Widths < 12" = 1" Borders

Edinburgh Patina

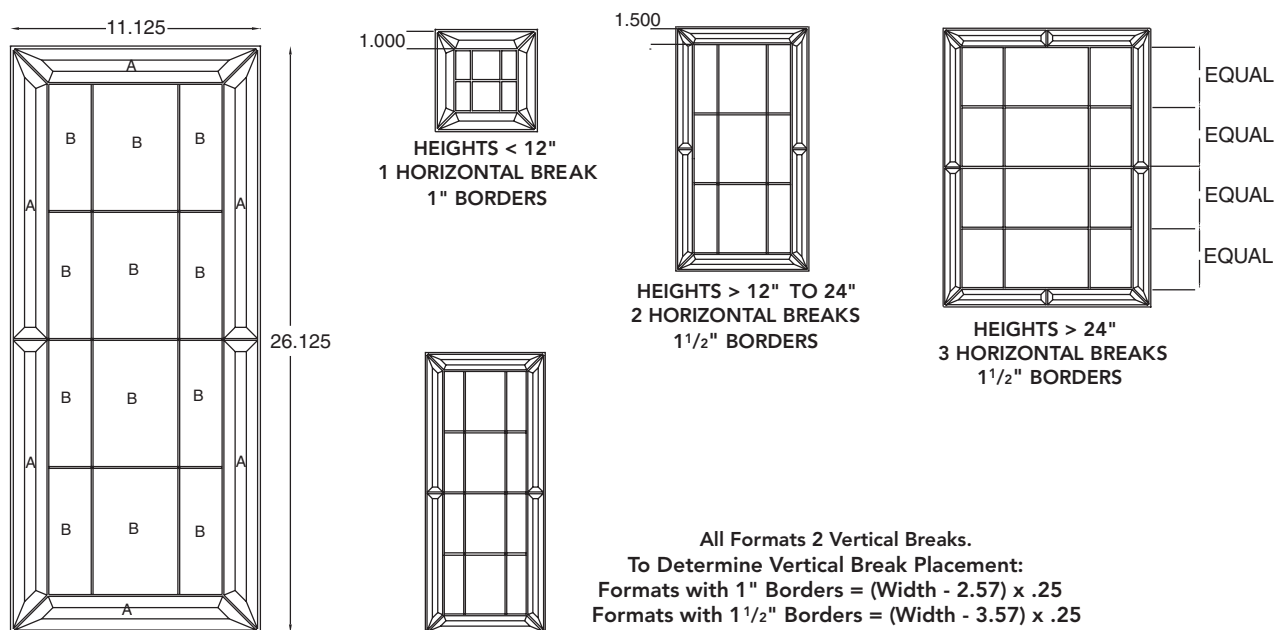

Glass Types:

- A) 3/16" Clear W/1/2" Bevel
- B) Clear Artique 100A

Metal Types:

3/16" H-CH Zinc PROGLAZE2 (All) Patina

Minimum Width 5 1/2"
Minimum Height 5 1/2"
Widths < 12" = 1" Borders

Specialty Doors

Hannover

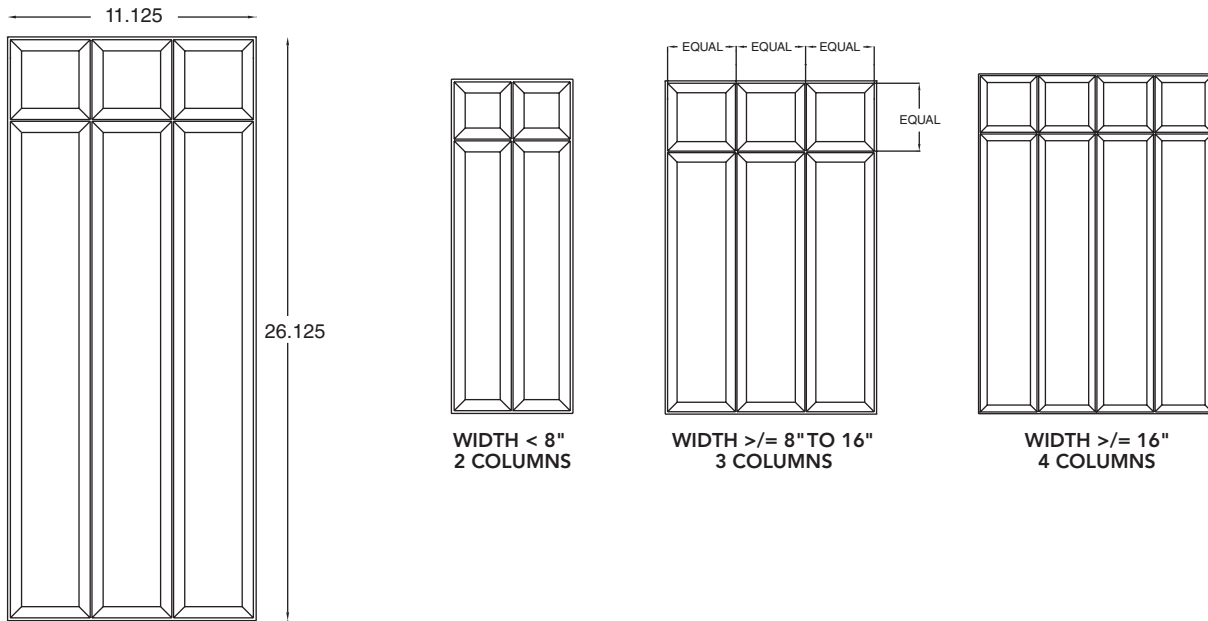

Glass Types:

A) $\frac{3}{16}$ " Clear W $\frac{1}{2}$ " Bevel (All)

Metal Types:

$\frac{3}{16}$ " HC-H Brass PROGLAZE2 (All)

Minimum Width $5\frac{1}{2}$ "
Minimum Height $5\frac{1}{2}$ "

Kensington

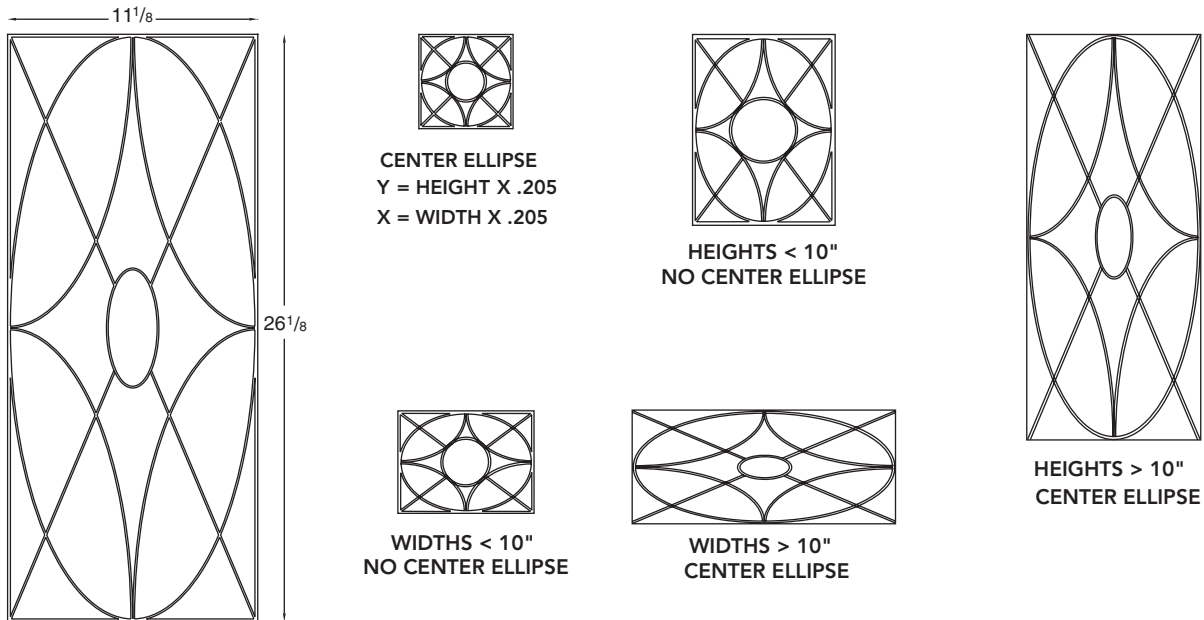

Glass Types:

A) $\frac{1}{8}$ " Clear Artique 100A (All)

Metal Types:

$\frac{3}{16}$ " H-CH Zinc PROGLAZE2 (All) Patina

Minimum Width $5\frac{1}{2}$ "
Minimum Height $5\frac{1}{2}$ "

Luxembourg

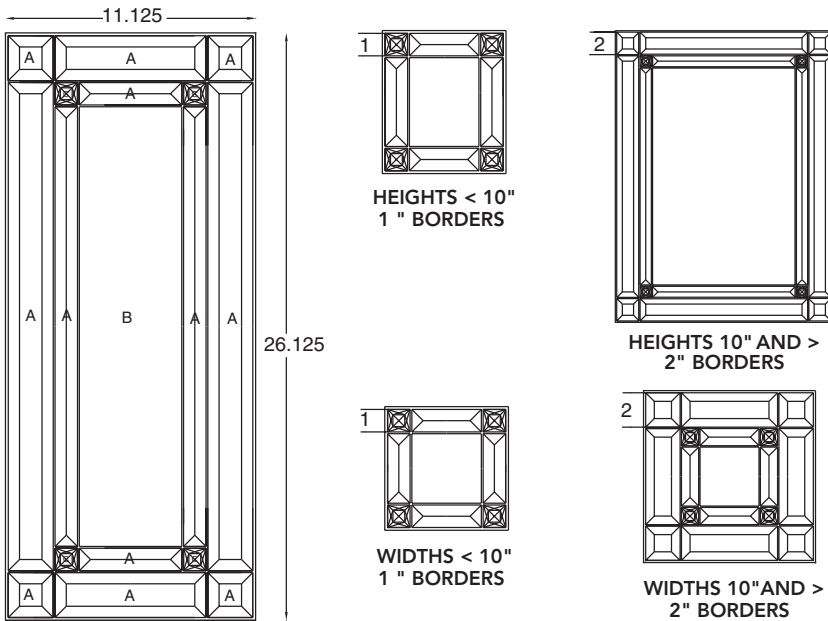

Glass Types:

- A) $\frac{3}{16}$ " Clear W/ $\frac{1}{2}$ " Bevel
- B) $\frac{1}{2}$ " Clear
- C) $\frac{3}{16}$ " Clear Jewel

Metal Types:

$\frac{3}{16}$ " H-CH Zinc PROGLAZE2 (All)

Minimum Width $5\frac{1}{2}$ "
Minimum Height $5\frac{1}{2}$ "

Nottingham

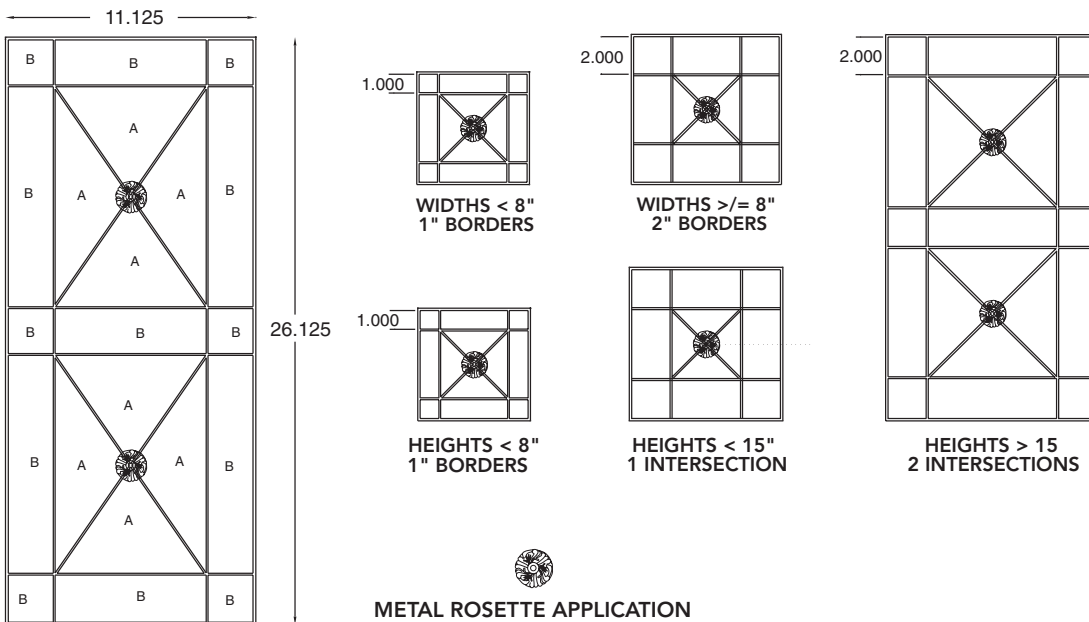

Glass Types:

- A) Clear Waterglass 100W
- B) $\frac{1}{8}$ " Clear

Metal Types:

$\frac{3}{16}$ " H-CH Zinc PROGLAZE2 (All)

Minimum Width $5\frac{1}{2}$ "
Minimum Height $5\frac{1}{2}$ "

Specialty Doors

Pasadena

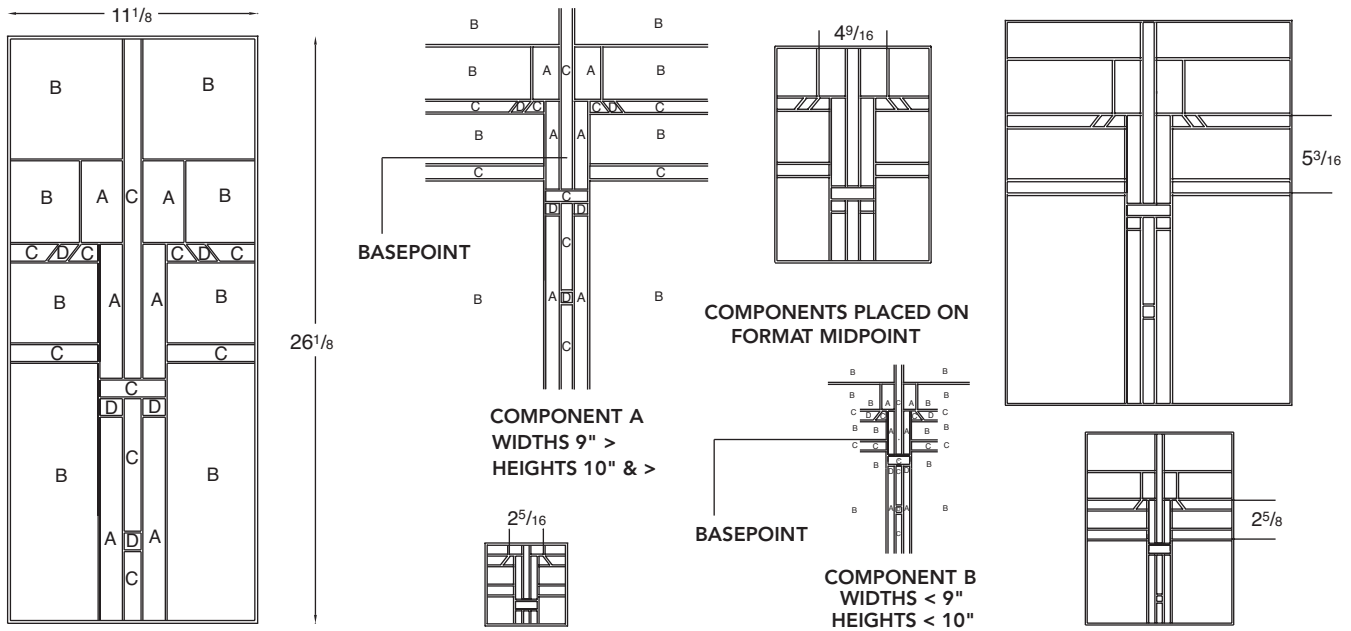

Glass Types:

- A) Sparkolite (Crystal Ice)
- B) Clear Rough Rolled 100RR
Clear Artique
- C) Light Amber and White Translucent 317-15

Minimum Width 5 1/2"
Minimum Height 5 1/2"

Metal Types:

3/16" H-CH Zinc PROGLAZE2 (All) Patina

Prairie

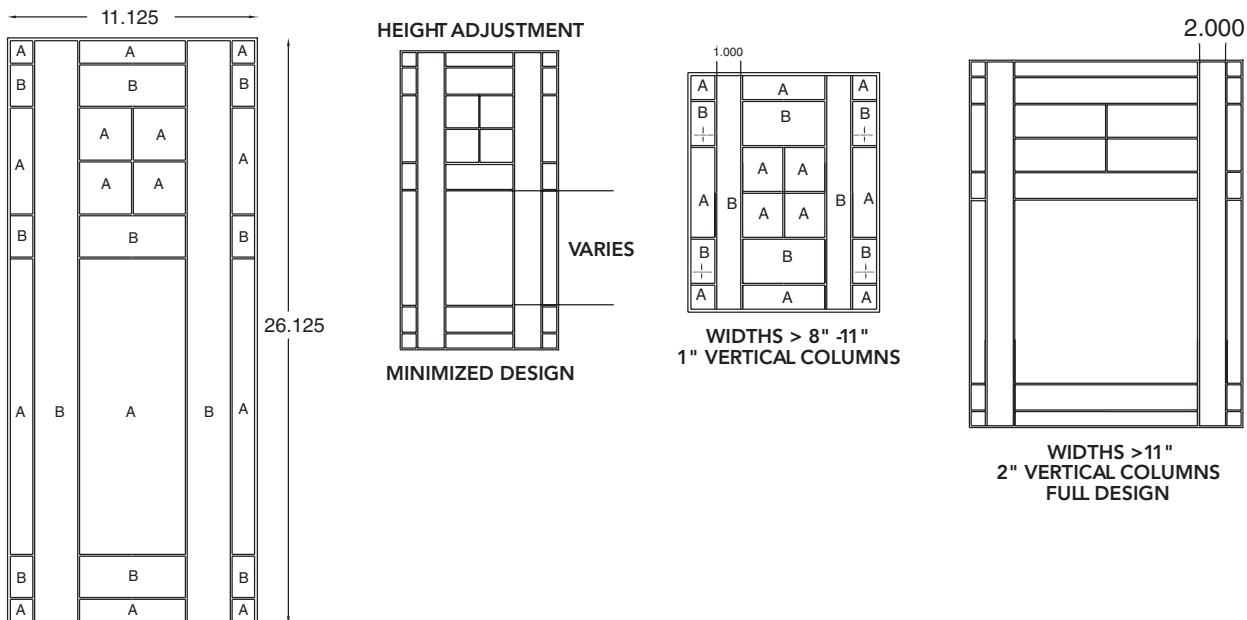

Glass Types:

- A) Clear Artique 100A
- B) Thin Reeded Clear 1/8" Reeds # 4034

Minimum Width 8"
Minimum Height 10"
(N/A in 9", 12", 15" Wide)
(N/A in 12" & 15" High)

Metal Types:

3/16" H-CH Copper PROGLAZE2



Tewkesbury

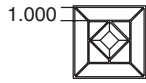
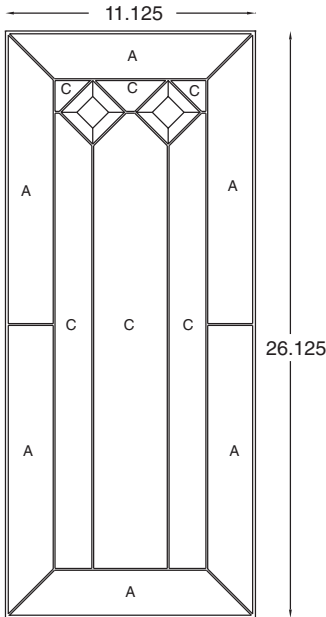

WIDTHS OR HEIGHTS < 8"
1" BORDERS

WIDTHS 5 1/2" TO 10"
1 COLUMN

WIDTHS 10" TO 13"
2 COLUMNS

WIDTHS > 13"
3 COLUMNS

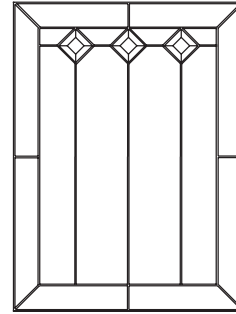
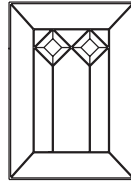
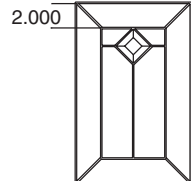

WIDTHS OR HEIGHTS > 8"
2" BORDERS

Glass Types:

- A) Clear Sparkolite
- B) 3/16" Clear W/1/2" Bevel
- C) 1/8" Clear

Minimum Width 5 1/2"
Minimum Height 5 1/2"

Metal Types:

3/16" H-CH Zinc PROGLAZE2 (All)

Windermere

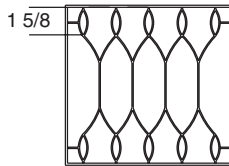
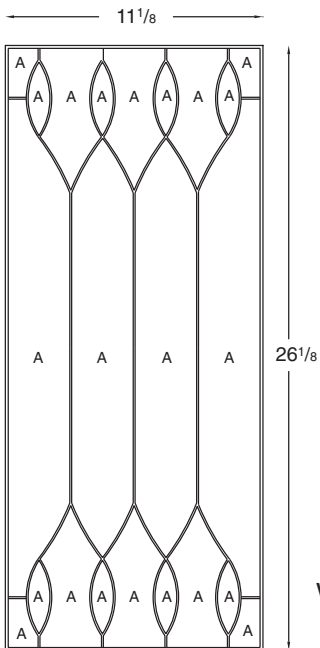

HEIGHTS < 10"

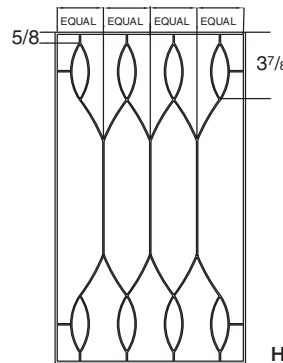

HEIGHTS > 10"



WIDTHS < 10"
2 COLUMNS



WIDTHS >= 10" < 13"
3 COLUMNS

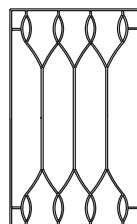

WIDTHS >= 13" < 16"
4 COLUMNS

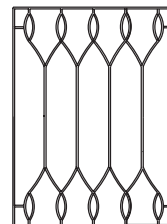

WIDTHS >= 16"
5 COLUMNS

Glass Types:

- A) Clear Baroque BR/CLR

Metal Types:

3/16" H-CH Zinc PROGLAZE2 (Patina)

Minimum Width 5 1/2"
Minimum Height 7"

Specialty Doors

Winslow

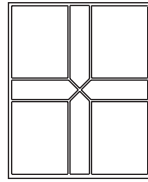
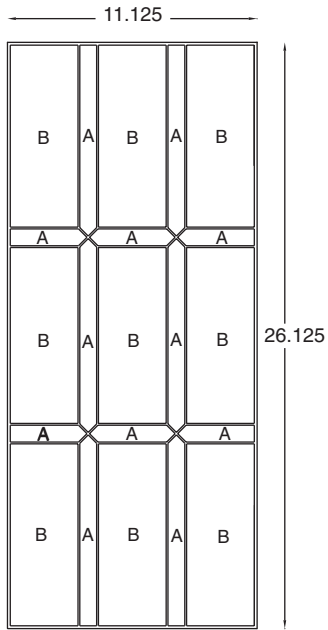

HEIGHT 5 1/2" TO 9"
1 HORIZONTAL COLUMN CENTERED

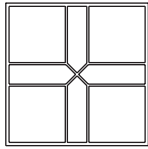

WIDTH 5 1/2" TO 9"
1 VERTICAL COLUMN CENTERED

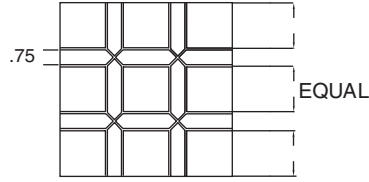

HEIGHT ≥ 15 "
2 HORIZONTAL COLUMNS
EQUALLY SPACED

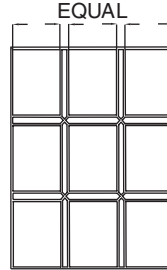

WIDTHS > 9 "
2 VERTICAL COLUMNS
EQUALLY SPACED

Minimum Width 5 1/2"
Minimum Height 5 1/2"

Glass Types:

- A) Clear Glue Chip
- B) 1/8" Clear

Metal Types:

3/16" H-CH Zinc PROGLAZE2 (All)